



## Solar Pumping Inverter User Manual



JNP-L2-EN-V1.1

# Solar pumping Inverter

## User Manual

JNP3KL

JNP3K7L

The copyright belong to Hefei JNTECH New Energy Tech. Co., Ltd.

This document involves the proprietary and confidential information about Solar pumping inverter of Hefei JNTECH New Energy Tech. Co. Ltd. It strictly prohibited to disclose the document by duplicating, photocopying, publishing online and in other forms without Hefei JNTECH's permission.

Hefei JNTECH New Energy Tech. Co., Ltd. reserves the right to change details in this publication without notice.

## Preface

### Manual Instruction

This manual describes the transportation, installation, operation, maintenance and troubleshooting of the following JNP inverters:

JNP3KL

JNP3K7L

In order to describe conveniently later, JNP3KL and JNP3K7L will be short for JNPxL, Solar pumping inverter will be short for inverter. The inverter type shall be pointed alone, when introduce the information about each type of inverter in details.

### Target Reader

This manual applies to the professional engineering and technical person who is responsible for installing and operating of inverter and LCD panel.

### Use the Manual

Please read this manual carefully before installing and operating inverter.





Please keep this manual well for operation and maintenance in future.

The manual content would be constantly updated and revised, but it unavoidably has slightly discrepancies or errors with real inverter, please kind prevail if user purchases our inverter.







### Symbol Used



The following safety symbols may be used in this manual, and the meanings are shown in below.

Safety Symbol	Meaning
---------------	---------

 <b>Danger!</b>	<p>Means that it may lead to serious accident of injuries, if safety warning is ignored.</p>
 <b>Warning!</b>	<p>Means that it may lead to serious accident of injuries, equipment serious damage or main business interruption, if safety warning is ignored.</p>
 <b>Notice!</b>	<p>Means that it may lead to moderate accident of injuries, equipment moderate damage or part of the business interruption, if safety warning is ignored.</p>
 <b>Note!</b>	<p>Means that the content is additional information.</p>

Inverter related symbols:

Symbol	Meaning
	<p>Direct current (DC)</p>
	<p>Alternating current (AC)</p>
	<p>Protective grounding</p>
	<p>Refer to relevant instructions</p>
	<p>Can not discard inverter together with domestic garbage</p>
	<p>Beware of dangerous high-voltage.</p>
	<p>Should wait for 5 minutes after inverter and PV panel are disconnected, then inverter only can be touched.</p>

	<p>Beware of hot surface</p> <p>The inverter temperature can exceed 60 during operation. Please don't touch the surface to avoid scald.</p>
	<p>CE certification marks. It means that inverter complies with the requirement of CE certification.</p>

# CONTENT

<b>PREFACE</b> .....	<b>II</b>
MANUAL INSTRUCTION .....	II
TARGET READER .....	II
USE THE MANUAL .....	II
SYMBOL USED .....	II
<b>1 SAFETY INSTRUCTIONS</b> .....	<b>1</b>
<b>2 PRODUCTION INTRODUCTION</b> .....	<b>6</b>
2.1 SOLAR PUMPING SYSTEM INTRODUCTION .....	6
2.2 PRODUCT’S INTRODUCTION .....	7
<i>2.2.1 Appearance</i> .....	7
<i>2.2.2 Production Dimensions</i> .....	8
<i>2.2.3 Product Name</i> .....	9
<b>3 INVERTER UNPACKING</b> .....	<b>10</b>
3.1 UNPACKING CHECK .....	10
3.2 IDENTIFY INVERTER .....	11
<b>4 INSTALLATION PROCEDURE</b> .....	<b>13</b>
4.1 PREPARE INSTALLATION TOOLS.....	13
4.2 INSTALLATION STEPS.....	14
<b>5 INSTALLATION</b> .....	<b>15</b>
5.1 INSTALLATION SITE REQUIRED .....	15

5.2	INSTALLATION DIRECTION.....	16
5.3	INSTALLATION OF INVERTER .....	17
<b>6</b>	<b>ELECTRICAL CONNECTION.....</b>	<b>19</b>
6.1	CONNECTING TERMINALS OF INVERTER .....	19
6.2	SCHEMATIC DIAGRAM OF ELECTRICAL CONNECTION .....	20
6.3	CABLE SELECTION .....	22
6.4	AC SIDE ELECTRICAL CONNECTION.....	22
6.5	DC SIDE CONNECTION .....	25
6.6	WATER LEVEL SENSOR CONNECTION.....	28
	<i>6.6.1 Water level sensor interface define.....</i>	<i>29</i>
	<i>6.6.2 Water level sensor connection.....</i>	<i>30</i>
6.7	COMMUNICATION CONNECTION .....	33
	<i>6.7.1 RS485 Communication.....</i>	<i>33</i>
	<i>6.7.2 GPRS Communication.....</i>	<i>34</i>
6.8	DISASSEMBLING .....	34
	<i>6.8.1 Safety Instruction.....</i>	<i>34</i>
	<i>6.8.2 Disassembling of Connector.....</i>	<i>35</i>
	<i>6.8.3 Mounting and dismounting of cover panel.....</i>	<i>37</i>
<b>7</b>	<b>COMMISSIONING .....</b>	<b>38</b>
7.1	VERIFY BEFORE COMMISSIONING.....	38
7.2	INVERTER COMMISSIONING .....	38
7.3	STOP FREQUENCY SETTING .....	40
7.4	TIME CALIBRATION .....	40
<b>8</b>	<b>LCD PANEL OPERATING INSTRUCTIONS.....</b>	<b>41</b>
8.1	INVERTER LCD DISPLAY .....	41

8.1.1 LED Indicator Direction .....	41
8.1.2 Description of Buttons.....	42
8.1.3 LCD Display Interface Overview.....	43
8.2 INITIAL OPERATIONAL INTERFACE .....	44
8.3 MAIN MENU.....	47
8.3.1 Operation Information .....	47
8.3.2 Basic Information.....	49
8.3.3 Statistic Interface.....	50
8.3.4 Parameter Setting.....	51
8.3.5 Fault Inquiry.....	61
8.3.6 Malfunction Warning.....	62
<b>9 MALFUNCTION AND TROUBLESHOOTING.....</b>	<b>64</b>
9.1 TROUBLESHOOTING .....	64
9.2 MAINTENANCE .....	67
9.3 CONTACT CUSTOMER SERVICE .....	68
<b>10 APPENDIX A .....</b>	<b>69</b>
<b>11 APPENDIX B .....</b>	<b>71</b>
11.1 QUALITY ASSURANCE .....	71
11.2 CONTACT US .....	72

# 1 Safety Instructions

For the electrical and electronics equipment, safety relates to the whole process of installation, commissioning, operation and maintenance. Therefore, incorrect use or operation would damage the life and personal security of operating person or the third party, and inverters.

In order to reduce casualties, damage of inverter and other equipments, user or operating person should strictly abide by all the safety information tips of danger, warning and notice which are in the process of operating and maintaining.



## **Warning !**

All the installation and operation of JNPxL series Solar pumping inverter must be completed by professional and technical person. Professional and technical person need:

- Receive special training

- Read this manual completely and master the operation related to safety matters. Any damage caused by improper installation or operation which do not according to the introduction in this manual will be beyond the warranty scope of Hefei JNTECH.

## **Before installation**



## **Notice !**

User should check the inverter if there is any damage during transportation. Please contact Hefei JNTECH New Energy Tech. Co., Ltd or transportation company immediately if some problems of inverter are found.

## **Installing**

Ensure inverter not have electrical connections and electricity before installing.



**Danger !**

The solar cell arrays should be covered with opaque materials when installing the photovoltaic arrays during the day, otherwise the solar cell arrays will generate high voltage ,causing person casualties.

**Electrical connections**



**Danger !**

Ensure that the solar cell array should be covered by light tight materials, before electrical connecting, otherwise, the solar cell array would produce high voltage under the sun to cause casualties.



**Warning !**

All the operation and wiring work should be operated by professional electrical or mechanical engineer.

Please do not close switch on breakers before all the equipments are not fully connected well.



## **Warning !**

If inverter damage caused by the following circumstances will be beyond the warranty scope of our company.

Ensure that the max. short-circuit of DC side is in the inverter allowable range when configuring PV arrays, otherwise, inverter may be caused non-recoverable damage.

Ensure that the open circuit voltage of JNPxL shall not exceed 450V when configuring PV arrays, otherwise, inverter may be caused non-recoverable damage.

It would influence the machine features and may cause machine damage if the installation environment is selected improperly.

Do not install the inverter in inflammable, explosive place or inflammable, explosive materials storage .

Don't install the inverter in explosive dangerous place.

Don't install the inverter in place where vulnerable to lightning strike.

Don't install the inverter in place where have much salt fog.

When running the inverter, please ensure good ventilation.

Inverter should be installed erectly, and ensure the heat sink, fans etc. are without shelter.



**Notice !**

All the electrical installation must meet the electrical installation standard of local and country.

In order to ensure safe running, proper grounding, using appropriate conductor size and providing short circuit protection are required.

Connection cable must select suitable specification, firm connection and good insulation.

**Running**



**Danger !**

AC connection should not be turned off directly when AC side of inverter with loads, DC connect need to be turned off firstly, and ensure that it has really no voltage, then DC connection should be turned off.

Please don't plug any connectors under inverter charged state!

Please don't open the cover plate under inverter charged state!



**Notice !**

Only LCD display screen and DC switches can be touched when the inverter is running, the heating devices (such as radiator, etc.) should not be touched to avoid scald.

**Maintenance**



**Danger !**

Maintenance should be done by professional maintenance technical person.

Please ensure that AC side breakers should be turned off firstly, then DC side breakers should be turned off before checking and maintaining, after waiting at least 5 minutes, should measure DC side and AC side voltage with a voltage meter, to ensure that operation under the circumstance of no voltage between DC side and AC side.

## 2 Production Introduction

### 2.1 Solar pumping System Introduction

Solar pumping system is different from traditional AC pumping system, which take use of solar cells to convert solar energy into electricity.

It consists of 4 parts: PV modules, PV Pump Inverter, 3 phase AC pump and water storage device. Solar Pumping Inverter converts DC power produced by PV module into AC power required by the pump motor. A microprocessor inside continuously monitor available energy levels and adjust pump speed, matching energy required to energy available. This enables the system to operate under varying solar isolation levels, and provide water throughout the day and through different seasons. The PV Pump Inverter utilize a high efficiency MPPT algorithm to maximize power harvested from PV module.



#### Warning !

Inverter can't be connected with the PV array, which is positive or negative grounded!

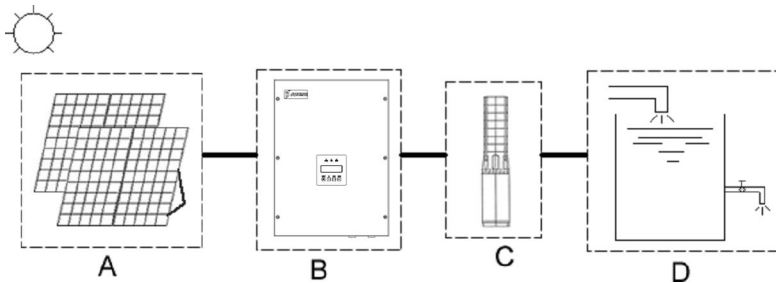

Figure2-1 Solar pumping application system

Table2-1 Solar pumping application system list

No.	Name	Description
A	PV array	Monocrystalline silicon, Polycrystalline silicon
B	Solar pumping inverter	JNP1K1L, JNP1K5L, JNP2K2L
C	AC pump	Three-phase AC pump
D	Water storage device	Can be the reservoir, fields etc.

## 2.2 Product's Introduction

### 2.2.1 Appearance

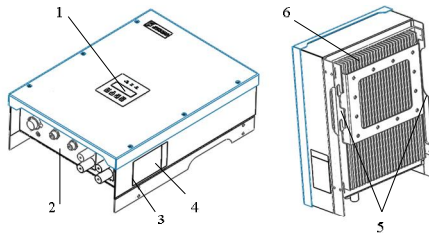

Figure2-2 Appearance of Solar pumping inverter

Table2-2 Inverter appearance information table

No.	Name	Introductions
1	LCD display screen	Man-machine interface, you can check the inverter operating information through LCD display screen, also can set some function and parameters of inverter.
2	Connection terminals	Including DC input terminal (PV1+/PV1-/PV2+/PV2-); output terminal (MOTOR); sensor connection terminal (SERSOR).
3	Nameplate	Inverter basic parameters listed on the nameplate for

		basic information about inverter.
4	Machine serial No.	Machine factory number, when need after-sales service should provide the No..
5	Hanger	Used to hang the inverter on the bracket.
6	Radiator	Help machine heat dissipation, the temperature is higher when inverter is running, don't touch!

### 2.2.2 Production Dimensions

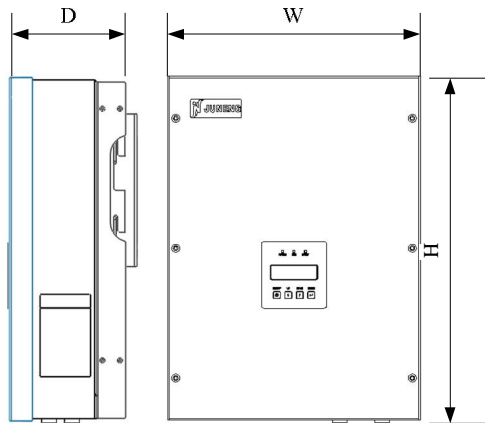

Figure2-3 Dimension drawing of Solar pumping inverter (unit : mm)

Table2-3 Inverter dimension table

Inverter type	Width(mm)	Height(mm)	Depth(mm)	Net weight( kg )
JNP3KL	330	450	152	12.5
JNP3K7L	330	450	152	12.5

### 2.2.3 Product Name

The way of product naming, take JNP3K7L for example:

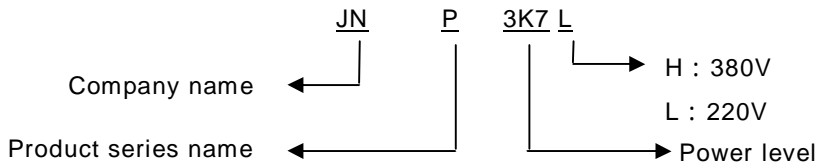

### 3 Inverter Unpacking

#### 3.1 Unpacking Check

The product has been tested and checked carefully before transportation, but damage may be caused during transportation, therefore, the product should also be checked carefully before installation.

Please check whether inverter outer packing is in good condition;

After unpacking, please check whether the equipment is in good condition;

According to the packing list to check whether all the parts is correct and in good condition.

If any damage is found, please contact Hefei JNTECH New Energy Tech. Co., Ltd. or the transportation company. Please keep well the photos taken at the damaged parts and we'll provide you with best and fastest services.

Hefei JNTECH New Energy Tech. Co., Ltd. supply the standard inverter and some commonly used accessories as below:

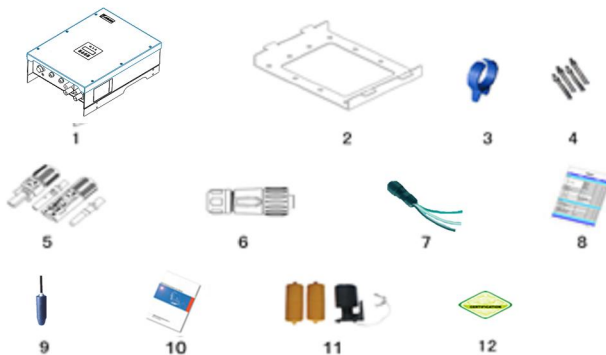

Figure3-1 Inverter and standard fittings

Table3-1 Inverter and fittings table

No.	Description	No.	Description
1	PV pump inverter	7	Sensor and communication connector (Optional)
2	Installation bracket	8	Packing list
3	Blue Ring tool	9	Water level sensor (Optional)
4	Expansion bolt	10	Quick Installation Guideline
5	PV connector	11	Water level sensor (Optional)
6	AC connector	12	Certificate of inspection

### 3.2 Identify Inverter

The nameplate in the side of inverter, and it shows the inverter model, some important parameter and certificate mark.

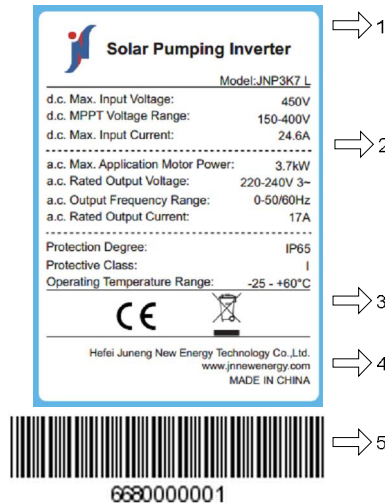

Figure3-2 Inverter nameplate

Table3-2 Nameplate information table

NO.	Description
1	JNTECH Logo and name
2	Inverter model and parameter information
3	Certificate and safety signs, concrete meaning as “Preface”
4	Company and address
5	Inverter factory number



**Note !**





Photos are for reference only, please adhere to the original products!

## 4 Installation Procedure

### 4.1 Prepare Installation Tools

The following tools will be needed during inverter installation and wire connection. You also can choose the right tools according to your own experience.

Table4-1 Installation tools list

Sketch map	Name	Recommend specification	Function
	Wire crimpers	M2.5~M8	Used for PV connector wire core pressure welding
	Electric drill	8	Used for inverter installation plate fixed hole drilling
	Straight screwdriver	3	Used for the AC wire installation
	Cross screwdriver	5	Used for disassembling inverter cover

## 4.2 Installation Steps

Tools ready, follow these steps to install

Table4-2 Installation process

Installation steps	Installation instruction	Reference chapters
1	Before installation, check whether the inverter is in good condition;	
	Whether the product fittings are complete	3.1
	Whether the installation tools and spare parts are complete	4.1
	Whether the installation environment meets the requirements	1
2	Read the manual, especially the "Safety Instructions"	1
3	Choose the best installation location	5.1
	Installation	5.3
4	Electrical connection	6
	Select cables	6.3
	AC side wire connection	6.4
	DC side wire connection	6.5
	Sensor wire connection	6.6
5	Commissioning	7
6	Configuration parameter	8

## 5 Installation

### 5.1 Installation Site Required

Inverter installation site environment has very important influence to the safe operation, the performance and life of the inverter. Choose the right installation site before install the inverter.

All installation must comply with local standards.

Do not install the inverter at a flammable or explosive place or a place where the flammable or explosive materials are stored.

Do not install the inverter in a place where there is a risk of explosion.

Do not install the inverter in places where the inverter is vulnerable to lightning strike.

Do not install the inverter in a higher salt spray environment

Inverter installation site must be in good ventilation, do not install the inverter in the closed case, otherwise the inverter will not work properly.

Inverter protection level is IP65, can be installed outdoor, when the inverter is installed outdoor, should be installed as far as possible in the eaves or other have the shadow place, avoiding direct sunlight, rain and snow.

Inverter is installed indoor, keep away from windows, avoiding lightning

The installation place selected should be solid enough to support the inverter weight for a long period.

The site for inverter installation must be clean and the ambient temperature must be maintained within -25 to +60 °C.

Inverter installation site relative humidity should not be more than 95%, water vapor may corrode inverter, and damage the internal components

The inverter must be installed in a place convenient for observation and

maintenance

Don't install the inverter in living area, the inverter will produce some noise when running, influence daily life.

## 5.2 Installation Direction

The inverter should be installed vertically or tilted backwards with a maximum angle of 10°.

Do not install inverter tilted forwards.

Never install the inverter horizontally.

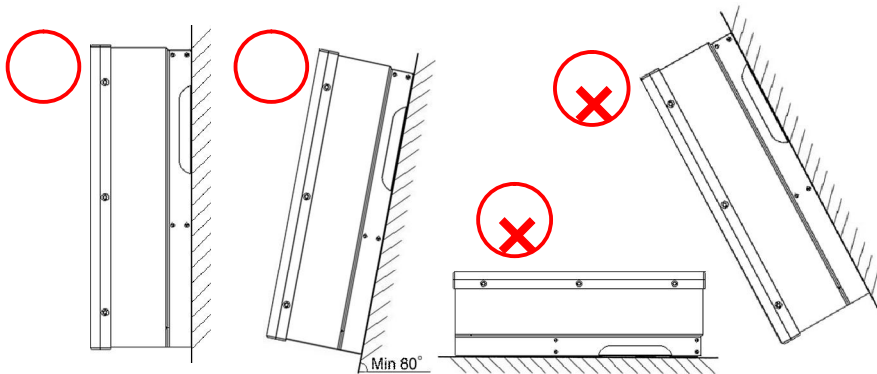

Figure5-1 Installation directions

The installation height of inverter should be convenient for operation and reading out of the LCD displayed information

Do not install the inverter in a place where children can touch.

The inverter uses air cooling mode and the installation site selected should ensure the minimum installation spacing between the inverter and the fixed object and the nearby inverters to ensure an good ventilation. And in front of the inverter need to keep enough space, is convenient to check the LCD display information.

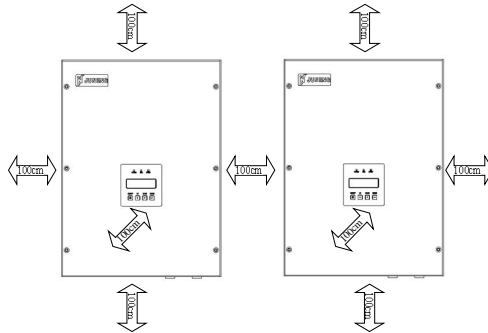

Figure5-2 Minimum spacing of adjacent installations

Table5-1 Minimum spacing dimension

Direction	Minimum spacing
Above	100cm
Below	100cm
Sides	100cm
Front	100cm

### 5.3 Installation of Inverter



**Note!**

Fix the inverter on the rock or panel with the toggle bolt or screw is not permitted.

JNTECH New Energy would provide the bolt which suitable for the installation on the concrete wall.

If the inverter is fixed on the wooden wall, please choose suitable bolt to finish the installation, the bolt length should be enough and penetrate the 1/2 depth of the walls.

**Step1:**

Drill holes in the selected installation position according to the size and shape of installation bracket.

**Step2:**

Fix installation bracket in the located holes with bolts.

**Step3:**

Tighten the bolts, make the bolts cling to the wall.

**Step4:**

Hang firmly inverter onto the installation bracket.

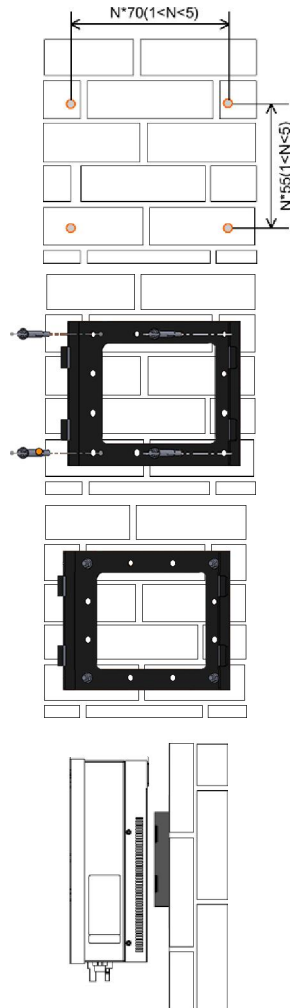

## 6 Electrical Connection

The electrical connection can be carried out when the mechanical installation of inverter is completed. The following operation specification must be followed when making electrical connection.



### **Warning !**

All the electrical connection must meet local electrical connection standard.

Only qualified electrical personnel can perform the wiring installation work.

Incorrect wiring operation may cause operating casualties or equipment damage permanently.

Ensure that there is no electricity in DC side before the electrical connection.

Grounding correctly, using proper conductor and taking necessary Short-circuit protection to ensure the safe operation of inverter.

Don't try to switch on any breaker before all the electrical connection is finished.

### 6.1 Connecting Terminals of Inverter

Please refer to Figure6-1.

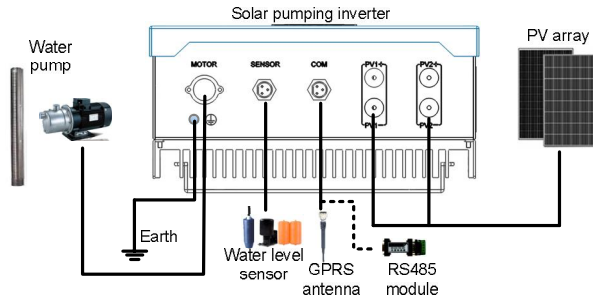



Figure6-1 External connection terminals of inverter

Table6-1 Description

Terminals	Description
PV1+ / PV2+	PV array DC positive input terminals
PV1- / PV2-	PV array DC negative input terminals
MOTOR	Output terminal, connect with AC pump
SENSOR	Water level sensor signal input terminal (optional)
COM	RS485 or GPRS communication interface (optional)
	Ground terminal

## 6.2 Schematic Diagram of Electrical Connection

Figure 6-2 is the schematic diagram of electrical connection among PV arrays, Solar pumping inverter and three-phase AC pump. Water level sensor and communication interface shall be connected if needed.

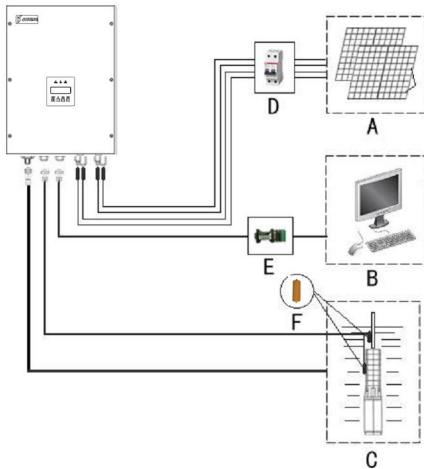

Figure6-2 Electrical connection diagram of Solar pumping inverter

Table6-2 Equipment list of Solar pumping system

No.	Equipment name	Description
A	PV array	The max. Voc of each string is 880V.
B	PC	Computer, used for monitoring system general information, and remote control inverter's start and stop, remote change system operation mode.
C	Pump	Three-phase AC pump
D	Communication module	Optional, can be purchased from Hefei JNTECH New Energy CO.,LTD
E	Water level sensor	Optional, for dry-protection
F	DC side breaker	Use for protecting electrical connection, user can configure it according to the max. input voltage and current value.
G	AC breaker	Use for protecting electrical connection, user can configure it according to the max. input voltage and

		current value.
H	GPRS antenna	Optional, Use for GPRS communication.

Table6-3 DC breaker selection

Inverter model	Recommended parameters of DC circuit breaker
JNP3KL	440VDC,25A
JNP3K7L	440VDC,25A

**Notice!**

It must be DC breaker, it's prohibited to be replaced by AC breaker.

DC Breaker

### 6.3 Cable Selection

Please select cable according to the following table.

Table 6-4 Specification of Cables for Electrical Connection

Inverter	Cable range ( AWG )			Cable recommended ( AWG )		
	DC side	AC side		DC side	AC side	
	PV+, PV-	U、 V、 W	PE	PV+, PV-	U、 V、 W	PE
JNP3KL	14-12	14-12	12	12	12	12
JNP3K7L	14-12	14-12	12	12	12	12

### 6.4 AC Side Electrical Connection



**Notice !**

It's forbidden to connect several inverters in parallel to one set of pump!



**Danger !**

Ensure that all cables have no charge before electrical operation!

**Step1:** Wire connection of the connector:

Please connect the wire of AC connector according to the following steps::

Operation Instruction	Operation Demonstration
<p>1. Unscrew all components.</p>	
<p>2. Prepare cable and bare the end 7mm of each wire. Insert the cable through the nut and middle sleeve.</p>	

3. Insert the bared wires U, V, W and PE into the corresponding four holes of the connector terminal and then fully tighten all screws. The phase sequence of each hole is signed around the holes. Please note that wire U must be connected to hole 1, wire V to hole 2, wire W to hole 3, and wire PE to hole  $\perp$ .

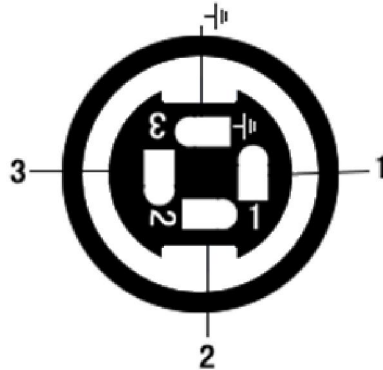

4. After fasten wires with terminal, combine every component together, and screw them tightly.

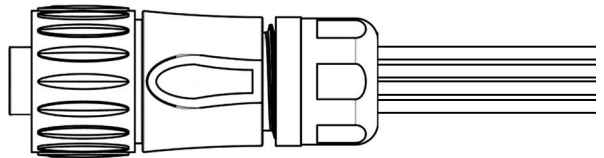

**Step2:** Plug the AC connector into the motor terminal at the bottom of inverter, please make sure that the connection is tight, otherwise, it may overheat, and lead to burn the connector.

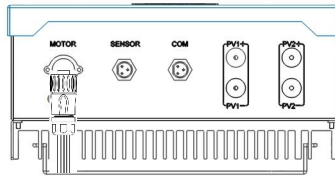

Figure6-3 AC side electrical connection

**Step3:** Connect the cables between pumping inverter and AC pump.



**Note !**

The phase sequence between AC pump and inverter must be same, otherwise, it shall lead to less output or without water. Whether Phase sequence is corresponding or not should be tested when the pump system trial run for the first time.

## 6.5 DC Side Connection



**Danger !**

When carrying the out connection between PV array and inverter, the PV array should be covered with opaque materials and the DC-side circuit-breaker should be disconnected, otherwise, the PV array may generate dangerous voltage, cause casualty. The Non-professionals do not make the connection operation.



**Warning !**

Before connecting PV array to the inverter, ensure the impedance between PV array with ground is not less than 1Mohm.



**Note !**

There have 1 or 2 pairs of DC input terminals, if 2 PV arrays are needed, make sure PV arrays are same, including the model of PV module, number, angle, azimuth, and connecting wires being with the same cross-sectional area.

Inspect every system carefully before installation.

**Step1:** Please connect the wire of DC connector according to the following steps:

Operation Instruction	Operation Demonstration
<p>1. Unscrew the nut from connector.</p>	
<p>2. Strip off one end of DC cable, 7mm around. Crimp the bare core to the tube with crimping pliers.</p>	
<p>Effect picture .Terminals and connectors match the core, is not reversed.</p>	

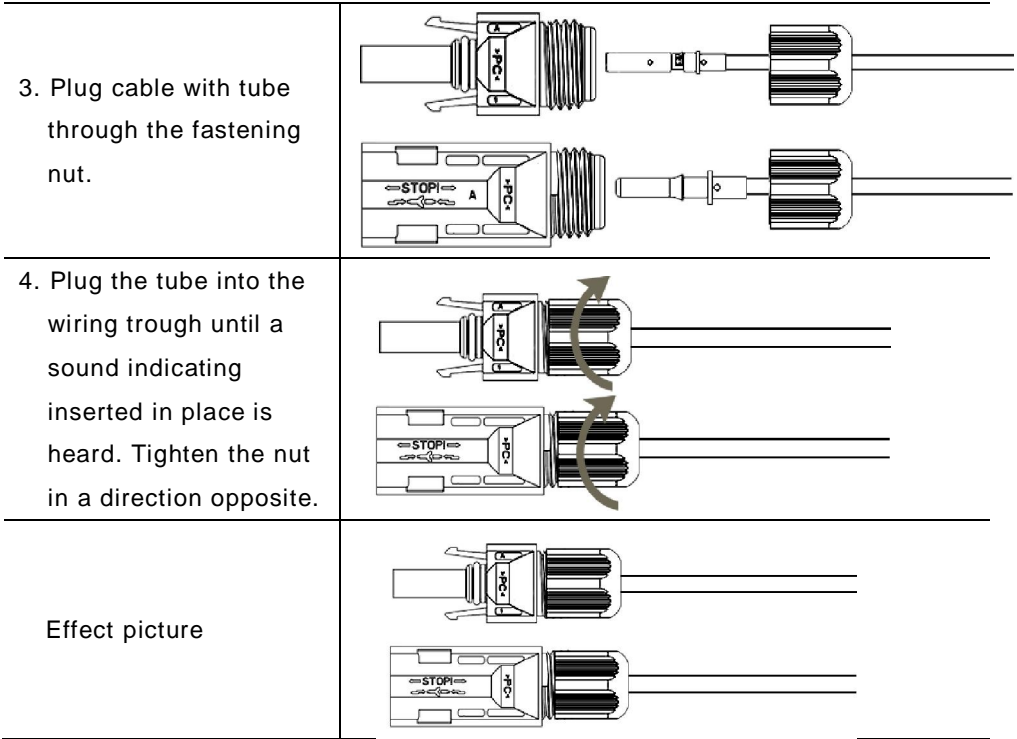

**Step2:** Ensure that the DC-side circuit breaker is off.

**Step 3:** Ensure polarity of PV array is right.

**Step 4:** Plug the positive and negative connectors into the corresponding terminals at the bottom of the inverter respectively.

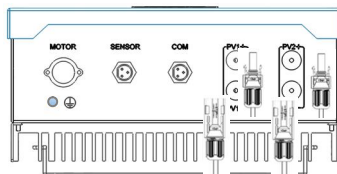

Figure6-4 PV side electrical connection

**Note !**

The nonuse terminals should be covered by taps.

**Warning !**

Make sure the plus & minus poles connection of PV array and Inverter are correct!

## 6.6 Water Level Sensor Connection

**Dry protection function:** There have two kinds of detection models, automatic and manual. Automatic dry protection is achieved through inverter's software. And manual model need water level sensors to input signal through SENSOR inside JNTECH Inverter.

**Overflow Protection:** water level sensors are requested to input signal through SENSOR inside JNTECH Inverter.



**Note !**

The water level sensors' location is designed according to your system situation.

Water level sensor can be bound in corresponding position on the pipeline connected to the pump. Other method also can be used to ensure the water level sensor is in the right position.

The installation of water level sensor must be reliable and effective.

When use water level sensor to achieve the function of dry protection, set “D-Mode” as “Detect”, please refer “**8.3.4.3 Key Parameters of the System Set**” for detail information.

When use water level sensor to achieve function of overflow protection, set “OF-F” as “On”, please refer to “**8.3.4.3 Key Parameters of the System Set**” for detail information.

**6.6.1 Water level sensor interface define**

Water level sensor connector pins in inverter panel port are defined are shown below:

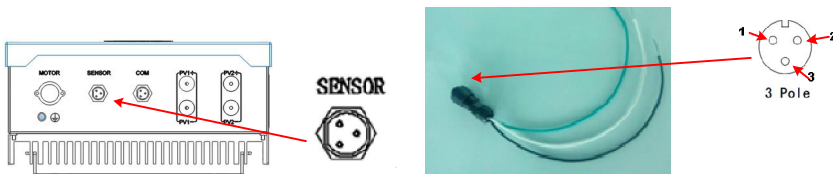

Figure6-5 Water level sensor interface define

Terminal ( SENSOR )	Detail
---------------------	--------

connector pin	
pin1	Dry protection pin, Connected black cable
pin2	Overflow protection pin, Connected white cable
pin3	Dry protection and Overflow protection common pin, Connected green cable

### 6.6.2 Water level sensor connection

Two kinds of water level sensor you can select are shown below:



Sensor A

Sensor B

Figure6-6 Water level sensor



#### Notice !

If you select overflow protection water level sensor, you need to set the value of "OF-F", the LCD menu "Settings" → "Para Set" → "OF-F" to modify to "ON". The setting method with reference to "**8.3.4.3 Key Parameters of the System Set**".

If you selected water level sensor A, then water sensor installation method is shown below:

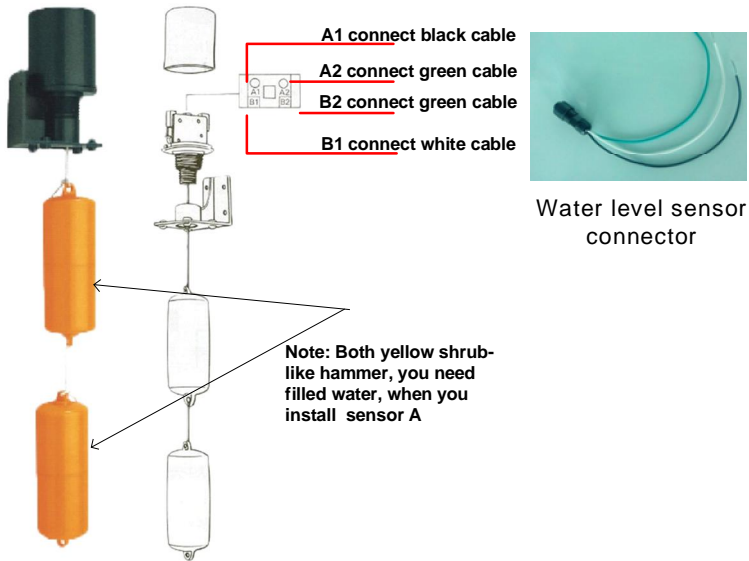

Figure6-7 The detail figure of Sensor A

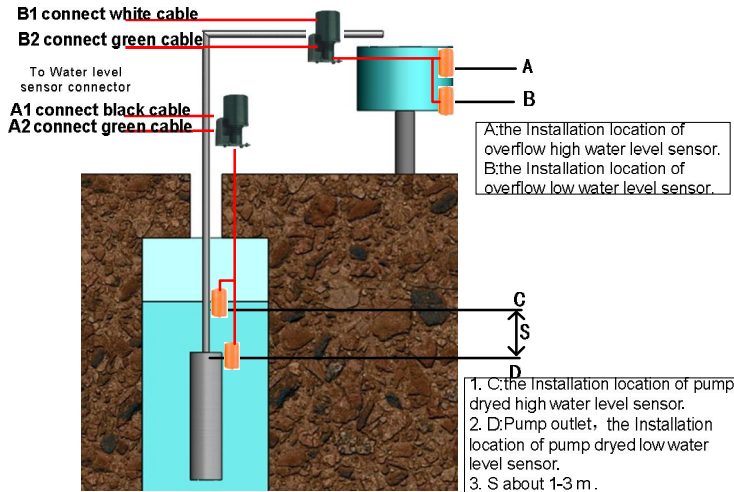

Figure6-8 The installation figure of Sensor A

If you selected water level sensor B, then water sensor installation method is shown below:

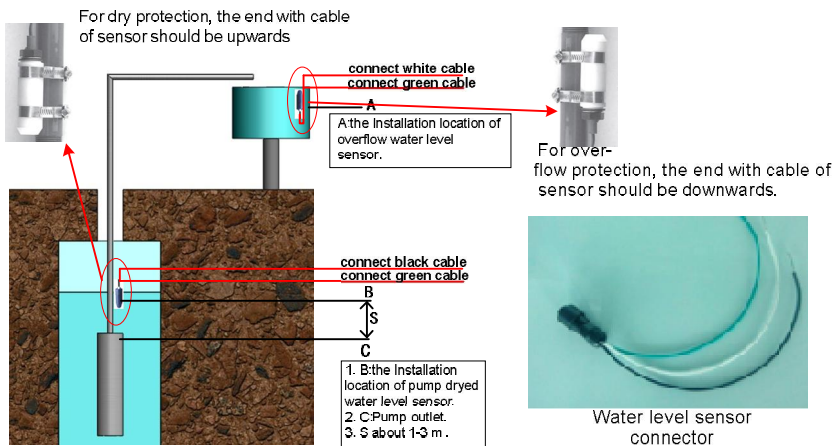

Figure6-9 The installation figure of Sensor B



**Notice !**

If you choose Water Level Sensor B, please note the following aspects when int all:

1. For dry protection, the end with cable of sensor should be upwards;
2. For over-flow protection, the end with cable of sensor should be downwards.

## 6.7 Communication Connection

### 6.7.1 RS485 Communication

RWP or UTP can be used in the connection between inverter and monitoring equipment.

The COM terminal outside is for remote communication, please refer to table 6-5, cross communicating wire through water-proof terminal to connect with A & B Amphenol connectors inside the machine.

The following diagram guide you to connect a single inverter to monitoring equipment.



Figure6-10 Diagram of single communication wiring

The wiring diagram is schematic diagram, just take HEXIN converting module as an example. If the user choose other converter, need according to the

converter's instructions, wiring the inverter's A, B wires to the converter's correct terminal.

Please refer to "**Inverter Management System User Manual**" for the corresponding monitoring software settings, after completing the wire connection.



### Note !

- | The monitoring software is optional, when choose this function, "**Inverter Management System User Manual**" can be found from the accompanying CD.
- | The inverter is supplied with default address "10".

## 6.7.2 GPRS Communication

Note : More information about the communication module, please refer to the **User and Installation Manual For GPRS**.

## 6.8 Disassembling

### 6.8.1 Safety Instruction



### Warning !

Before disassembling the inverter:

Turn off the DC switch.

Waiting for a few minutes to ensure the inverter is uncharged.

Please don't insert or pull out of any connector when the inverter is in a state of charged. Otherwise, it would cause personal injury and equipment damage.



**Notice !**

Electrostatic discharging will cause damage to the inner components of inverter. We should carry out the antistatic measure before disassembling and assembling.

**6.8.2 Disassembling of Connector**

**1. The Disassembling of PV Connector**

PV connector of inverter is not limited to one type, if the connected PV connector needed to be removed, according to the connection manner of connector to operate.

The professional tool, which is designed specifically for PV connector, if the connected PV connector need to be removed, it can help to pull out the connected PV connectors easily.

Please operate as following:

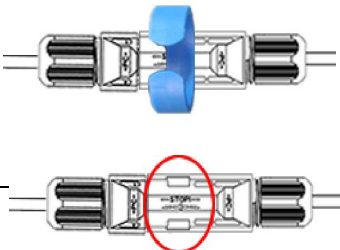
Operation instructions	Demonstration picture
Ring tool	
Step 1: Putting the professional tool into the holes of the PV connector totally, as shown on the picture, the connectors are disengaged.	

<p>Step 2: Remove the connector.</p>	
--------------------------------------	--

**2.The Disassembling of AC Connector**

No professional tools required. Just unscrew the connector as shown on the picture.  
Please operate as following:

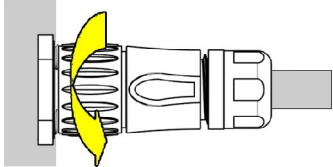
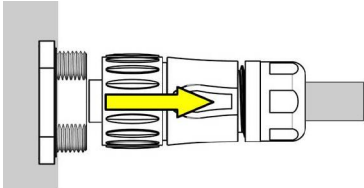
Operation instructions	Demonstration picture
<p>Step 1: Unscrew the nut as shown on the picture.</p>	
<p>Step 2: Remove the connector.</p>	

**3. The Disassembling of Communication Connector**

No professional tools required. Just unscrew the connector as shown on the picture.

Operation instructions	Demonstration picture
------------------------	-----------------------

Step1: Unscrew the nut as shown on the picture.

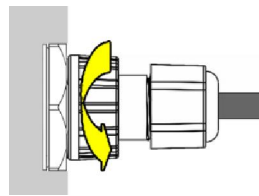

Step2: Remove the connector.

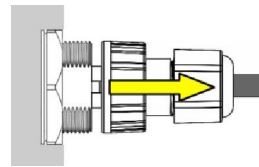

### 6.8.3 Mounting and dismounting of cover panel

For any special reason, you may need to disassemble the cover, and ensure better seal performance, please operate according to the following instruction.

1. When disassemble inverter cover, use the cross screwdriver, screw the cover screw in turn, and then disengage the grounding wire from the grounding screw of the inverter cover.
2. When do mounting of cover, first connect the grounding wire to the grounding screw of the cover. Then put cover on, use the cross screwdriver, the torque is  $1.8\pm 0.2\text{N}\cdot\text{M}$ , lock the cover screw in turn.

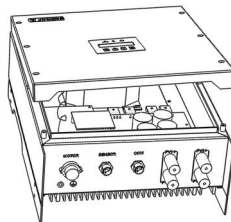

Figure6-10 Reference picture of Mounting and dismounting

## 7 Commissioning

### 7.1 Verify before Commissioning

#### **PV Arrays**

The PV array should be checked before operating the inverter, and to ensure that the positive and negative mustn't be misconnect, otherwise, the damage may be caused to the inverter. Make sure that the open-circuit voltage of photovoltaic array doesn't exceed the required voltage.

#### **DC Input**

Make sure that the DC terminals of the inverter are connected correctly and maintained consistent with the PV array.

#### **AC Output**

Make sure that the AC-side of inverter is connected correctly, and phases of AC-side are connected correctly.

#### **Verify of the water pump motor parameters**

Check the electrical parameters on water pump motor nameplate: the rated input voltage and input current frequency, to ensure inverter is matched with the pump.

### 7.2 Inverter Commissioning

Choose suitable weather, with enough sunshine, and make sure the normal operation of your solar pumping system. Try to ensure that inverter work under high output power, high output frequency as much as possible. Please make sure the following condition before commissioning.

Ensure that the inverter is connected correctly to the AC motor.

Ensure that the polarity of PV arrays is correct.

Ensure that the AC and DC terminals are connected firmly.

Check whether the system pipeline is unobstructed or not;

Switch on the DC-side circuit breakers.

After finishing the above steps, then begin initialization.

According to the pump motor rated current value on the nameplate, setting inverter overload protection value, the method is: modify the "Imotor" value equal to the motor rated current, the details please refer to chapter "**8.3.4.3 Key Parameters of the System Set**". "Imotor" settings.

After finishing the above steps, machine shall start operation after long-time pressing the "ON/OFF" key for 4s; check if the solar pumping system works properly or realize suitable head of delivery and flow. Press "ON/OFF" and stop the inverter.



#### Note !

Output power of inverter drives the pump working; the pump will stop working while the inverter stops.

System commissioning, may be abnormal, such as no flow, or flow rate cannot reach the designed value, or even the three phase water pump issued by abnormal sound. Please kindly check below:

- a) Three-phase AC pump reversal (saying three-phase pump connected wrong), you need to set "M-Mode", please refer to the Chapter "**8.3.4.3 Key Parameters of the System Set**".
- b) Output power of PV module is too weak; If the first trial run is abnormal, the inverter doesn't work, please refer to the Chapter

- c) The pump selected is not suitable. The head and the flow is less than the actual design demand.

## 7.3 Stop Frequency Setting

Solar pumping system for the first time trial run is successful, need to set the system shutdown frequency, as follows.

Step 1: Ensure the system is running and there has water output. To enter “StopFreq” interface. Please refer to “**8.3.4.3 Key Parameters of the System Set**”.

Step 2: To reduce the value of “StopFreq”. Reduce 5 each time (every change need to press “ENTER” to confirm). Keep reducing till there just has no water output, and make a small change to just get small water come out, and the value is the very data of “StopFreq”.

Step 3: Escape the “StopFreq” interface.

Finish the debugging.



### Note !

The set of “StopFreq” can ensure inverter stop working when the output power of PV array is too weak to pump water, which can increase the pump’s lifespan.

## 7.4 Time Calibration

The initial time in the inverter is based on Beijing time zone. Please reset time if it doesn't match local time so that the inverter can record daily, total generating capacity and historical faults information.

Please refer to “**8.3.4.1 Display Time Set**”.

Finished the commissioning of the Solar pumping system.

## 8 LCD Panel Operating Instructions

### 8.1 Inverter LCD Display

There have three LED lights, four buttons on the LCD Display, shown in figure 8-1.

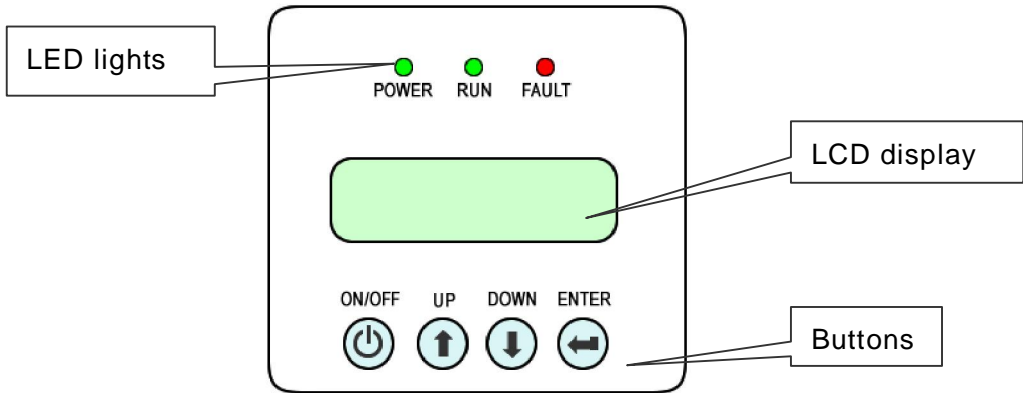

Figure8-1 LCD Display

#### 8.1.1 LED Indicator Direction

Table8-1 LED Indicator Direction

LED Indicator	Name	Color	Instructions
POWER	Power light	Green	Light on When power on
RUN	Running light	Green	Light on under normal operation
FAULT	Faulty light	Red	Light on when error occur, off when fault disappear

#### Detail Explanation of Indicator

When inverter is powered up, "POWER" indicator (green) will be lighted.  
 Communication fault occurs, "FAULT" indicator flashes rapidly.  
 Other outage or shutdown mode occurs, "FAULT" indicator will be lighted,  
 until fault or status are cleared.  
 When invert is running normally, "RUN" indicator will be lighted.

### 8.1.2 Description of Buttons

Table8-2 Buttons Function Table

Buttons	Functions
"ON/OFF"	Press once to stop; long time press for 4s to get it started.
"UP"	Page up and increase data.
"DOWN"	Page down and decrease data.
"ENTER"	To choose and confirm.
"DOWN+ENTER"	Return to main interface.



**Note !**

When inverter is powered up, LCD display background is lighted,  
 and after 30s normal running, the background light turns off.

### 8.1.3 LCD Display Interface Overview

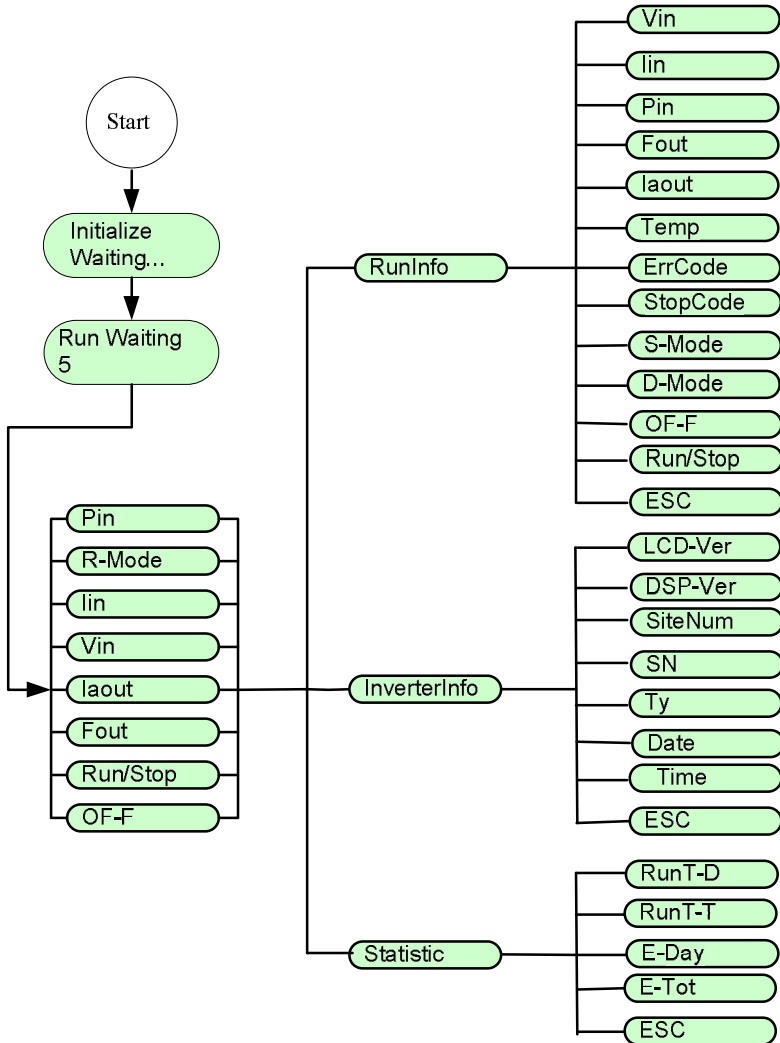

Figure8-2 LCD diagram ( 1 )

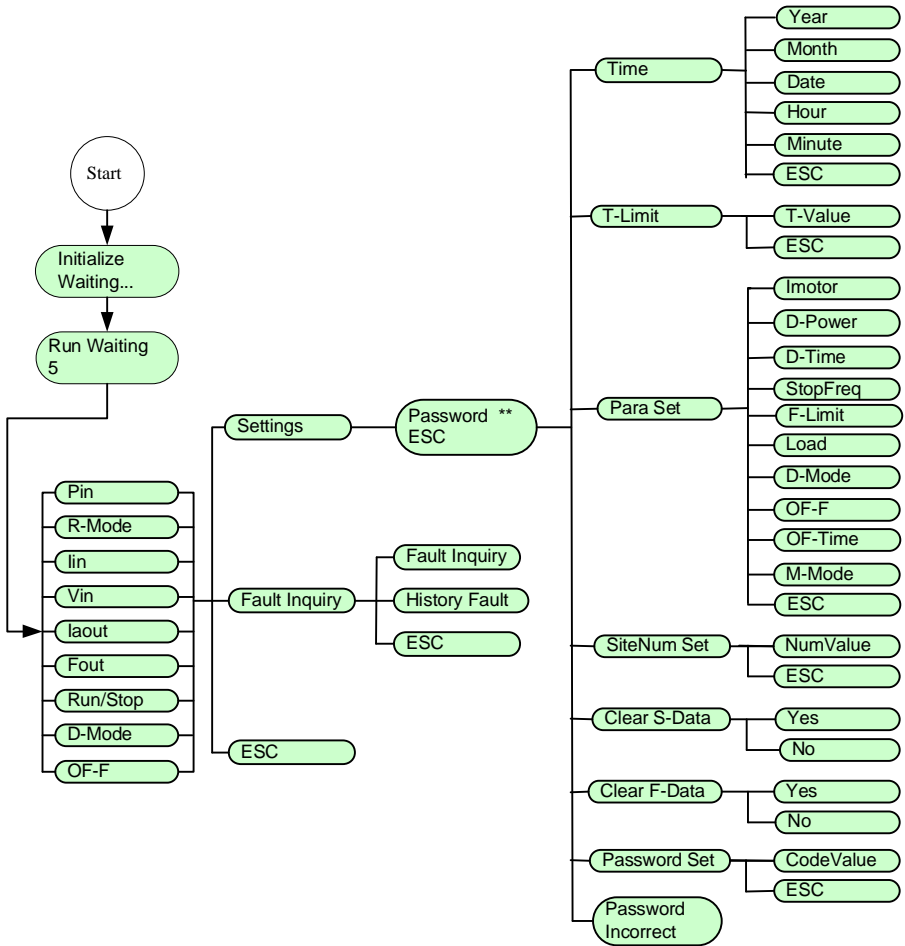

Figure8-3 LCD diagram ( 2 )

## 8.2 Initial Operational Interface

Once the inverter power on, the system start to initialize, display the initialization interface:

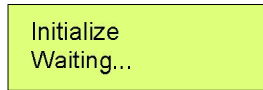

Figure8-4 System initialize

If the start-stop mode is auto., countdown interface will be display after initialization complete, and when countdown finished, LCD will enter the main interface, inverter will drive water pump. "RUN" indicator light.

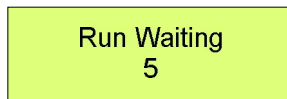

Figure8-5 Countdown interface

If the start-stop mode is manual mode (factory setting), the inverter is run to drive pump after long-time pressing "ON/OFF" key.



**Note !**

The default mode of inverter is manual start-stop mode. When inverter power for the first time, it need key-press to start the inverter to drive pump.(Run after long-time press "ON/OFF"), at the same time, manual start-stop mode will change into automatic start-stop mode directly.

Press "ON/OFF" stop the inverter and it will get started while long-time pressing "ON/OFF", if not do like this, the system won't start.

LCD display two lines of characters.

After inverter initializing, main interfaces will be displayed circularly:

Pin	0W
R-Mode	MPPT
Iin	0A
Vin	0V
Iaout	0A
Fout	0.00Hz
Run/Stop	Stop
D-Mode	Auto
OF-F	Off

Figure8-6 Main interface

Main interface display basic running information. Main interface will turn page auto after 10s, or you can turn page through pressing "UP" and "DOWN" button.

Figure8-3 The meaning of main interface parameters

Parameters	Instructions
Pin	Inverter input power (W)
R-Mode	Operation mode, MPPT
Iin	Inverter input current (A)
Vin	Inverter input voltage (V)
Iaout	Inverter A phase current (A)
Fout	Inverter output current frequency (Hz)
Run/Stop	Run or stop state
	Run: Inverter running Stop: Inverter stop, and pump stop work
D-Mode	Dry mode of PV pump system: "AUTOMATIC" doesn't need external water level sensor, "DETECTION" need external water level sensor.
OF-F	The optional function of overflow alarm in PV pump system

	<p>On: Inverter has over-flow protection function, If user's solar pump system include water storage device, this parameter should be set to "ON".</p> <p>Off: The inverter has no overflow alarm If the factory setting about inverter is "OFF".</p> <p>Note: To realize overflow alarm function, there need install external water level sensor, please refer to "6.6 water level sensor connect" for detail.</p>
--	---

### 8.3 Main Menu

When the main interface is displayed, press "ENTER", then enter the main menu and set or query the detail data, or set the function.

Table8-4 Information list of main menu

Name	Explain
RunInfo	Display running data of inverter
InverterInfo	Display basic information of inverter
Satistic	Statistical information of running time data and power inverted
Settings	Inverter's parameter setting
Fault Inquiry	Inquire current and historical fault
ESC	Return to the previous menu

#### 8.3.1 Operation Information

RunInfo, display the running information of the inverter, please refer to the

figure below.

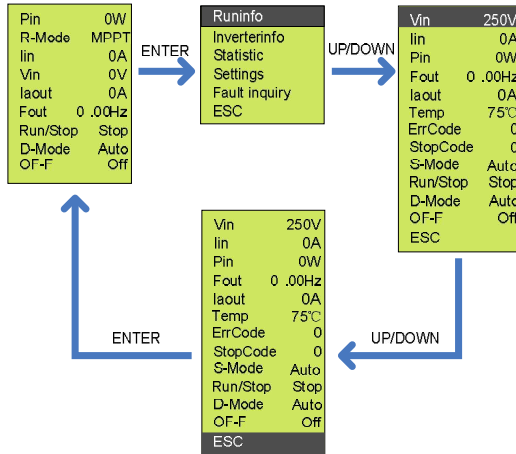

Figure8-7 Procedure of running data inquiry

Table8-5 RunInfo datas

RunInfo	Introduction
Vin	Inverter input voltage(V)
lin	Inverter input current(A)
Pin	Inverter input power(W)
Fout	Inverter input current frequency(Hz)
laout	Inverter output A phase current(A)
Temp	Inverter radiator's temperature( )
ErrCode	The most recently error mode
StopCode	Stop code, can check the reason of inverter shut down most recently.
S-Mode	Start and stop mode
D-Mode	Protection mode against well dry out.
OF-F	Water overflow alarm function optional in PV pump system

	storage device.
Run/Stop	run /stop status.
ESC	Return to the previous menu

### 8.3.2 Basic Information

InverterInfo, shows basic information of inverter, please refer to the figure below.

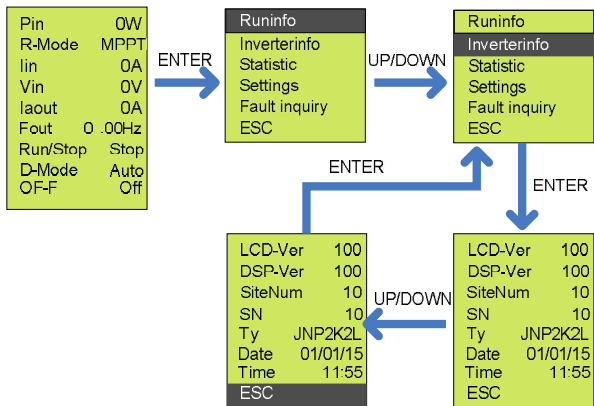

Figure8-8 Procedure of information inquiry

Table8-6 Detail information of inverter

InverterInfo	Explain
LCD-Ver	Version information of LCD program.
DSP-Ver	Version information of DSP program.
SiteNum	Site number of network node of inverter, when communicate with RS485. Default value is 10. If modifiable, please refer to“8.3.4.4Site Number Set”.
SN	Series number of inverter.

Ty	Type of inverter.
Date	Current day, from left to right shows day, month and year. This figure is modifiable, please refer to “8.3.4.1 Display Time Set”.
Time	Current time, modifiable, please refer to “8.3.4 Display Time Set”.
ESC	Return to the previous menu

### 8.3.3 Statistic Interface

Statistic, statistic of the totally running time and power generation of inverter.

Please refer to figure below.

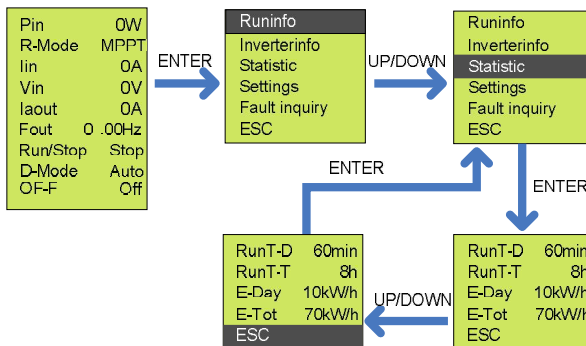

Figure8-9 Statistic data inquiry procedure

Table8-7 Detailed statistic data

Statistic	Explain
RunT-D	Inverter daily running duration. This figure will be reset when recharged.

RunT-T	Accumulative running duration. This figure can be reset manually. Please refer to “8.3.3Statistical Data Clear”.
E-Day	Daily power inverted. This figure will be reset when recharged.
E-Tot	Accumulative power inverted, can be reset manually. Please refer to “8.3.3Statistical Data Clear”.
ESC	Return to the previous menu

### 8.3.4 Parameter Setting

Settings, set the parameter, please refer to the figure below.

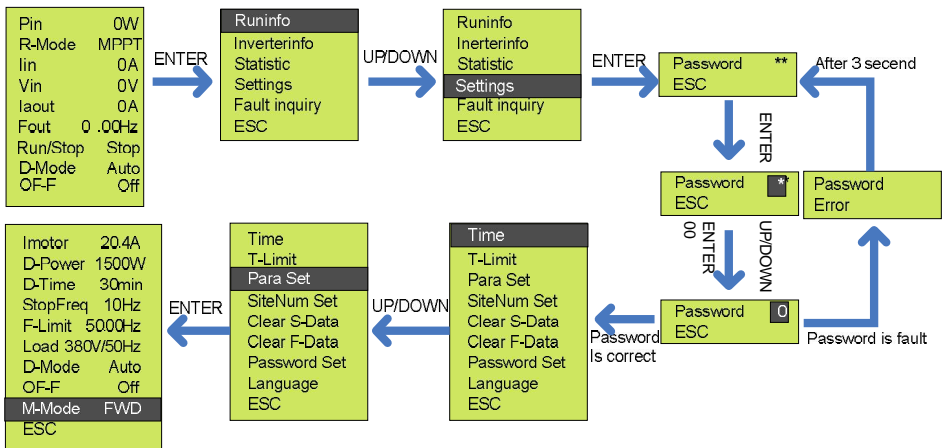

Figure8-10 Parameter setting



#### Note !

Default value of factory password is 00.

Table8-8 Inverter setting

Settings	Explain
Time	Adjust LCD display time.
T-Limit	To set the stopping time according to user requirement, inverter will stop running automatically as setting.
Para Set	For user to set the critical parameters of Solar pumping system.
SiteNum Set	Site number setting for RS485 remote communication.
Clear S-Data	To clear total running time and cumulative output power.
Clear F-Data	To clear historical faults' records.
Password Set	Password setting of entering setting menu.
ESC	Return to the previous menu.

#### 8.3.4.1 Display Time Set

Time, LCD display time set, to adjust LCD display time. Please refer to the figure below.

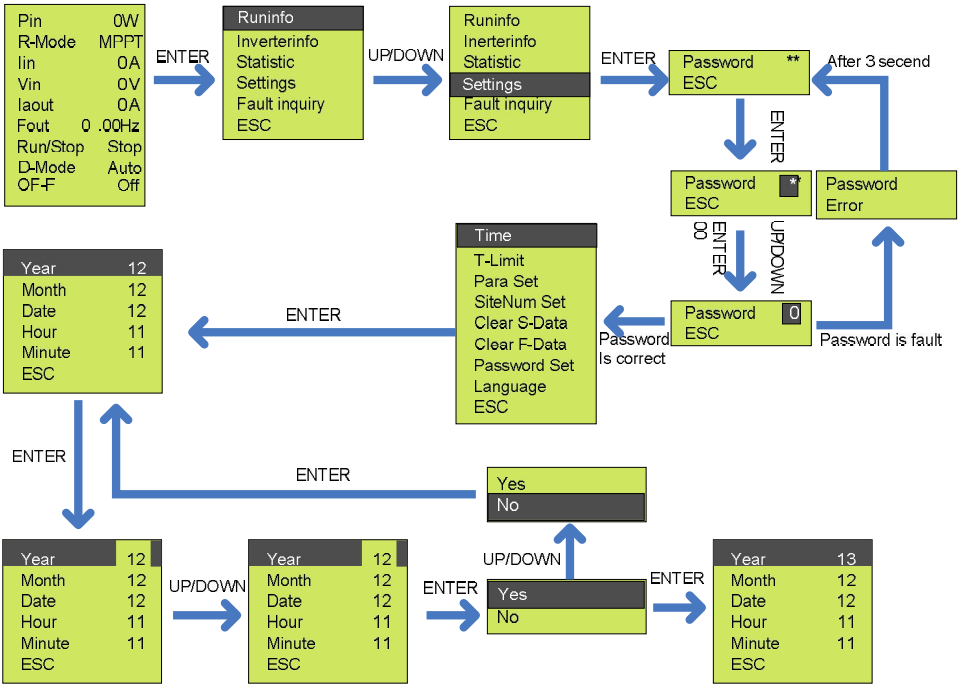

Figure8-11 Procedure of display time set



**Note !**

Here just taking the “Year” setting as an example, the “Date” and “Time” setting are same as “Year”.

Table8-9 Inverter time set

Time	Explain
Year	Adjust LCD display year
Month	Adjust LCD display month

Date	Adjust LCD display date
Hour	Adjust LCD display hour
Minute	Adjust LCD display minute
ESC	Return to the previous menu.

### 8.3.4.2.Timing Shutdown Time Set

T-Limit, to set timing shutdown time of the inverter. Please refer to the figure below.

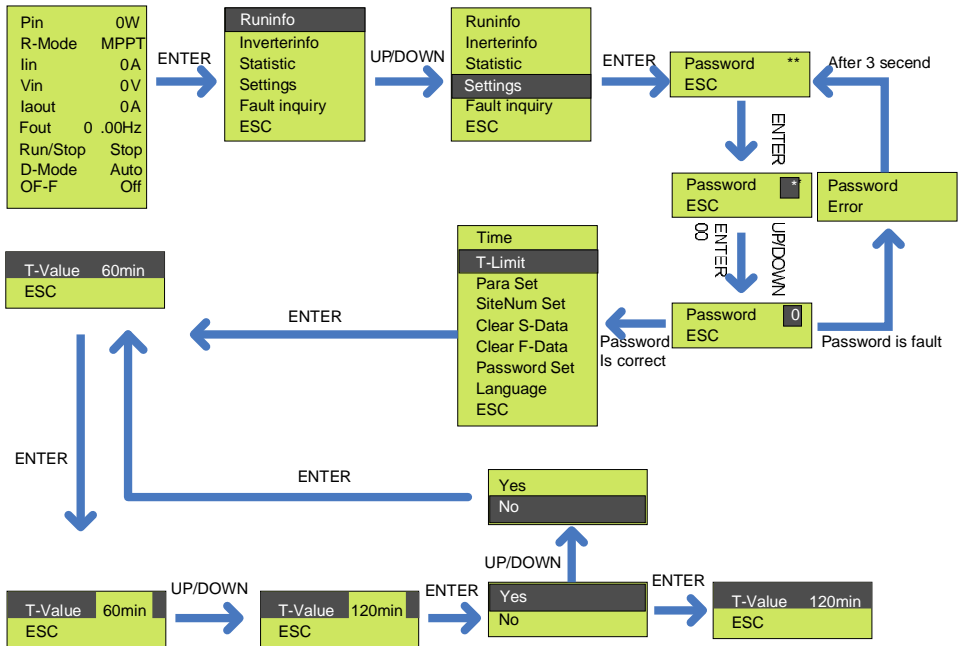

Figure8-12 Procedure of timing set

### 8.3.4.3.Key Parameters of the System Set

Para Set, to set the key parameters when your chosen pump is not matched to

the rated power of Inverter. Please refer to the figure below.

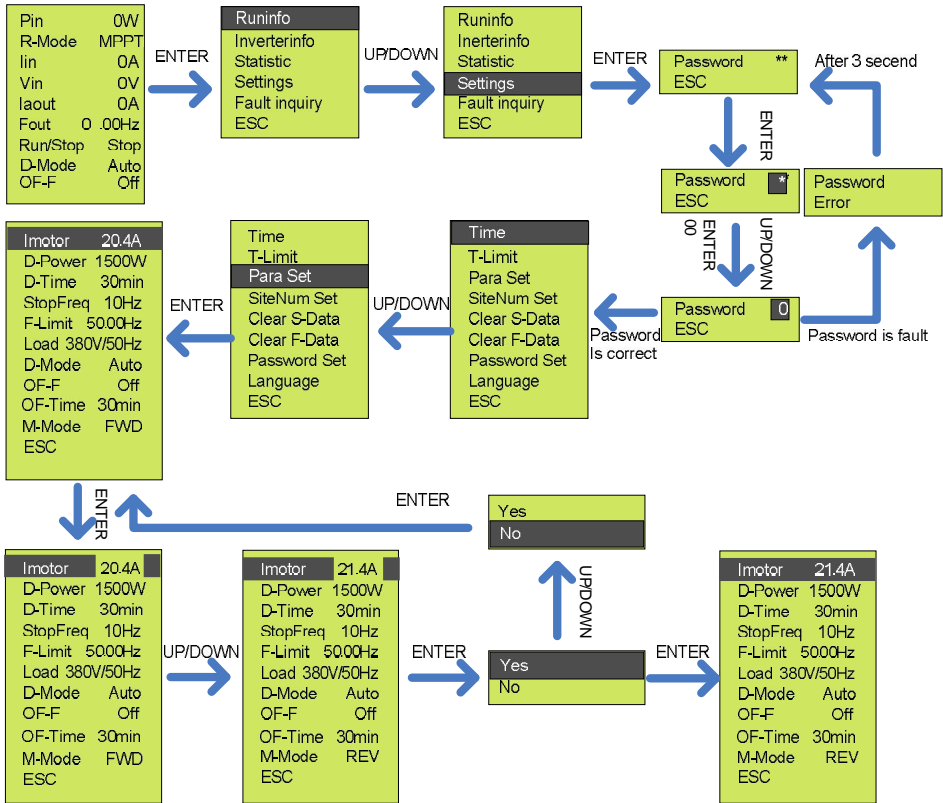

Figure8-13 Procedure of key parameters reset



**Note !**

Just take “Imotor” set as an example, other setting is the same.

Table8-10 Loading matching set

Para Set	Explain
Imotor	The pump motor over-load protection value when over-load, please refer to the rated current of motor to set this parameter, which should match motor over-load capacity, recommended to equal the rated current of motor.
D-Power	Dry protection power, which shall be reset when the load power rating is lower than Solar pumping inverter. Recommended value is 40% of the rated output power of Inverter. For example, the D-Power of 1.1kW pump is 440.
D-Time	Dry out recovery time, under auto dry out mode, after the warning of dry out and inverter shut down, the duration from shut down to restart. Default value is 30. Default duration is 30 minutes.
F-Limit	To set the stopping frequency according to user requirement, inverter will stop running automatically as setting. Default is "50Hz".
StopFreq	Stop frequency (Hz). Setting principle is stop frequency when minimum flow is output.
Load	For selection of load. This figure differs by different pump.
D-Mode	For choose the dry out protection mode. When water sensor is applied, dry protection mode should be set to detect dry protection. Default is "DETECT".
OF-F	For choose over flow warning function. Default is no overflow warning. If you want to use this function, please set to "on". Default is "OFF".
OF-Time	For choose over flow warning function. Over flow recovery time, after the warning of over flow and inverter shut down, the duration from shut down to restart. Default value is 30. Default duration is 30 minutes.

M-Mode	If water output is abnormal, and caused by reversed motor phase sequence, you can try to reset this model from “REV” to “FWD”.Default is “FWD”.
ESC	Return to the previous menu.



**Notice !**

Those parameters cannot be changed easily, only when you get JNTECH New Energy engineer’s recommendation.

JNTECH New Energy Inverter is not allowed to be used to drive the pump, which rated power is higher than its max. applicable motor output power.

**8.3.4.4.Site Number Set**

SiteNum Set, for remote RS485 communication use. Please refer to the figure below.

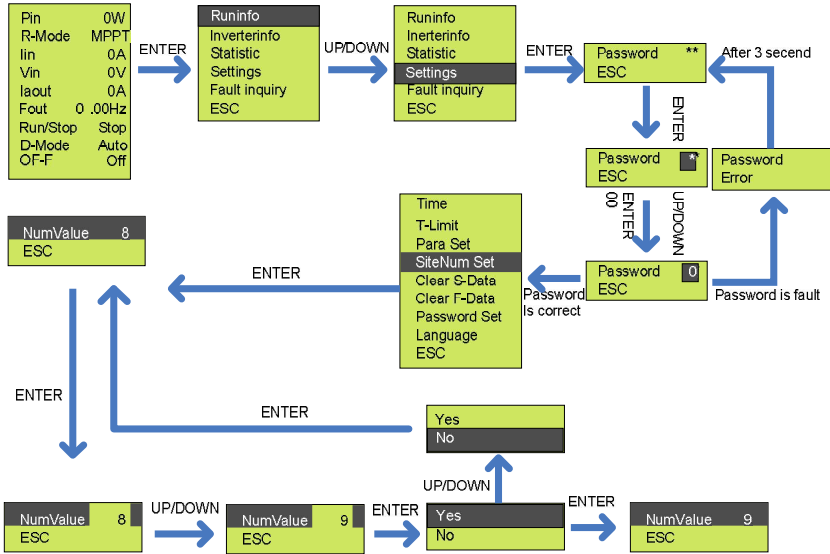

Figure8-14 Procedure of site number set



**Note !**

"SiteNum Set" maximum value is 64.

**8.3.4.5.Statistical Data Clear**

Clear S-Data, reset accumulated running duration and power inverted figure. Please refer to the figure below.



Figure8-16 Historical malfunction clear

### 8.3.4.7.Password Set

Password Set, to set the password to enter set menu, please refer to the figure below.

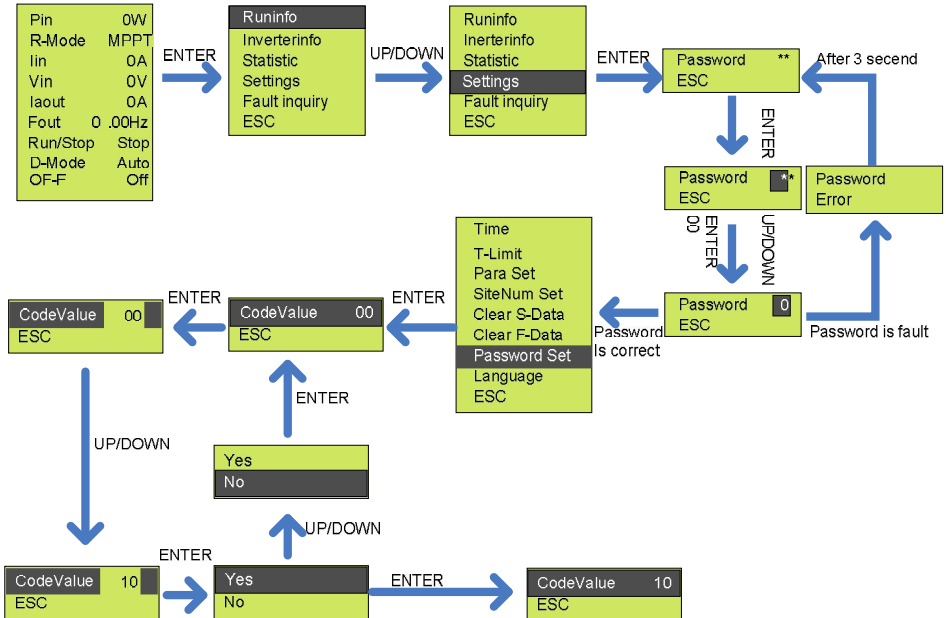

Figure8-17 Procedure of password set

### 8.3.4.8 Language Set

Language set, to set the man-machine interface language category, please refer to the following steps to operate.

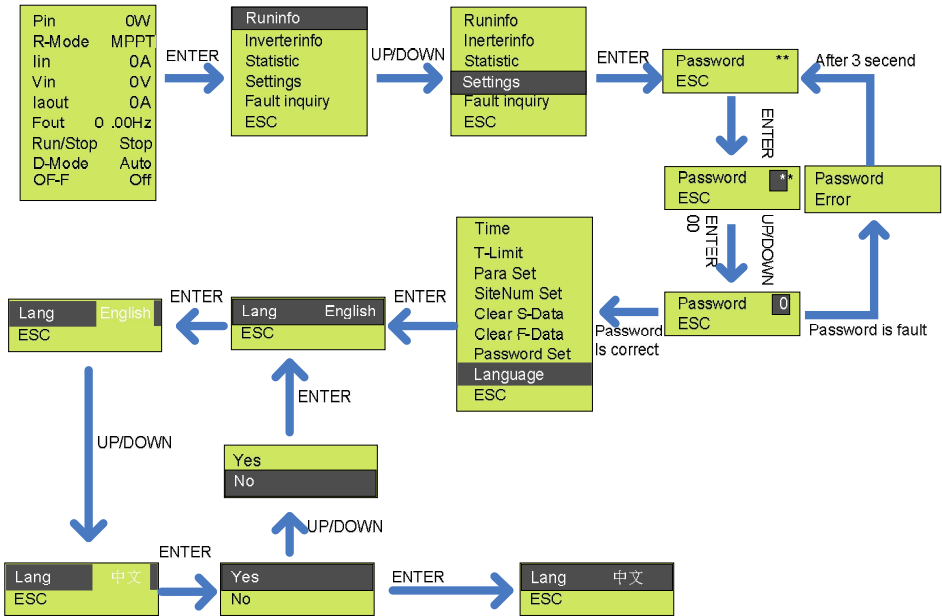

Figure8-18 Procedure of language set

### 8.3.5 Fault Inquiry

Fault Inquiry, to inquiry current and historic malfunction.

Table8-11 Fault inquiry

Fault Inquiry	Explain
Current Fault	Current fault inquiry
History Fault	History fault inquiry
ESC	Return to the previous menu.

Current Fault, to enquire current malfunction, Please refer to the figure below.

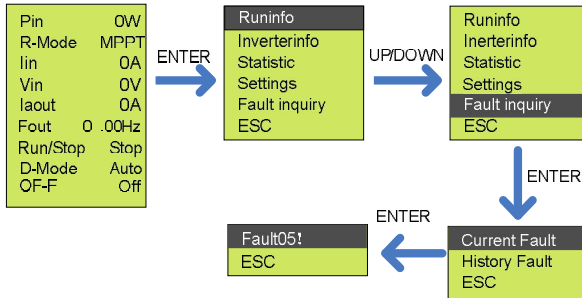

Figure8-18 Procedure of the current fault inquiry

### 8.3.6 Malfunction Warning

If communication failure appears, the below interface will appear.

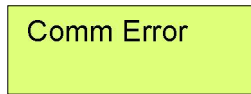

Figure8-19 Communication error screen

This interface will appear, and Fault red led flickers to show malfunction, this means internal communication malfunction is appear.

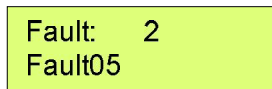

Figure8-20 Fault screen

Display show malfunction, fault LED lights up, shows inverter malfunction or stop. Press “UP” or “DOWN” to inquire current malfunction, choose “ESC”, press “ENTER” to quit. ( When LCD screen show fault code, and fault LED lights up, which mean inverter fault or stop. Press “UP” or “DOWN” to inquire current fault, choose “ESC”, press “ENTER” to quit. )



**Note !**

Malfunction manual reset function: when the machine breakdown with malfunction, can long press "ON/OFF" button, the machine can automatically restart immediately. When the machine is displayed Fault12, no such reset function.

Fault code and the corresponding meaning are listed below

Table8-12 Malfunction and condition code

LCD showed code	Name of malfunction and condition
Fault00	Driving over-current
State01	Array voltage low
Fault04	Radiator over heating
Fault05	Output over-load
Fault06	Array over-voltage
Fault07	Array over-current
Fault08	AC over-current
State09	Dry alarm
State10	Weak sunshine
Fault11	Temperature sensor fault
Fault12	Short circuit fault
Fault13	Initialization error from the machine
State14	Overflow alarm
Fault15	Output phase lose

## 9 Malfunction and Troubleshooting

### 9.1 Troubleshooting

Once malfunction or stop condition appears, the malfunction LED will lighten up, LCD will display current malfunction or stop condition, current malfunction will be recorded by the system for later inquire. Please refer to the form below which covers the fault and troubleshooting.

Table9-1 Stop condition and trouble shooting

Condition code	Phenomena	Cause value	Troubleshooting
State 01	Inverter shutdown when the fault appeared and will automatically restart after it disappear	Out put energy from array changes	Please check the input voltage from array and make sure this voltage inside inverter input voltage range. Note: In cloudy days, morning, or down, this situation is not malfunction.
State 09	Inverter shut down until the water level higher than High-level water level sensor and after protect recovery time , the machine will restart.	Water level of source is lower than low-level water level sensor, even lower than inlet of pump.	1.Please check the water level, if the water level is ok, please check if there are air inside pump. 2.Please check the position of water level sensor.

State 10	Inverter shutdown. When malfunction disappear, inverter can restart automatic.	Array output low.	Usually appears in early morning, dusk and cloudy days. This situation is aim to protect the motor of pump and lengthen the lifetime.
State 14	Inverter shut down, until water level is recovery and after over flow recovery time, this warning will disappear.	Water level in container higher than high-end level sensor.	If this situation appears more than once, please check onsite and set the water level sensor at a proper height.

Table9-2 Malfunction and troubleshooting

Condition code	Phenomena	Cause value	Troubleshooting
Fault00	Inverter shutdown and will restart automatically after the fault disappears	Short circuit in output wire	Please check if there is short circuit in output wires
Fault05	Inverter shutdown and will restart automatically after the fault disappears	Load higher than rated output power of inverter.	1.Please make sure the system is proper designed. The power of pump motor should not be larger than inverter output. 2.Make sure that the pump is working in the well range of head and flow.

			3.Please refer to “8.3.4.3” to raise the figure of Imotor.
Fault06	Inverter shutdown and will restart automatically after malfunction disappears	DC input voltage higher than maximum input voltage of inverter	Please check maximum output voltage of array and make sure this voltage is below inverter maximum input voltage
Fault07	Inverter shutdown and will restart automatically after the fault disappears	Input current of inverter higher than rated maximum value	If this happen, please contact Hefei JNTECH.
Fault08	Inverter shutdown and will restart automatically after the fault disappears	<p>1.Power capacity of pump motor is higher than rated output.</p> <p>2.Pump motor locked-rotor, or damaged.</p> <p>3.Pipe system design is not reasonable</p>	<p>1.Please inspect whether pump motor is normal.</p> <p>2.Please inspect whether pipeline system is in accordance with water pump or not.</p> <p>3.If this happen frequently, please contact Hefei JNTECH.</p>
Fault11	Inverter shut down	Sensor not connect proper or damaged	If this happen frequently, please contact Hefei JNTECH.

Fault12	Inverter shutdown, non-recover malfunction. No automatically restart, only if recharged	Output wire short circuit.	1. Please check if there is short circuit in output wires. 2.If this happen frequently, please contact Hefei JNTECH.
Fault15	Inverter shutdown and will restart automatically after the fault disappears	Phase loss in inverter output	1. Please check if the output wires are proper connected and fixed. 2.If this happen frequently, please contact Hefei JNTECH.

## 9.2 Maintenance

Please check and ensure the inverter is not charged with electricity before any maintenance.

### A routine examination must be done every half year:

- Check the inverter for damaged or with deformation.
- Check whether there is abnormal noise when inverter is running.
- Check whether the parameters and time settings are correct.

### Every half to one year, a routine examination should be done:



### Warning !

Please check and make sure the inverter is not charged with electricity before any maintain work below.

Check humidity and dust of inverter surrounding environment, if have too much dust, clean the inverter.

Check the inverter cable connection is loose, if loose, tightening again according to the connection method of wire.

Check whether the cable is damaged, especially the metal surface contact surface is cut marks or not.

### **9.3 Contact Customer Service**

If you have any question about Solar pumping inverter, please contact us,

Telephone : +86-551-62931312 ( 0323 )

Email : sales@jnnewenergy.com

In order to provide faster and better service, please provide us with information below:

Model of Inverter

Series number of inverter

Malfunction name and time

Malfunction description

# 10 Appendix A

## Technical Data

Item \ Model	JNP3KL	JNP3K7L
<b>DC input</b>		
Max. input DC voltage	440Vdc	440Vdc
Recommended MPPT voltage	150-400Vdc	150-400Vdc
Max. input DC current	21A	24.5A
Max. MPPT efficiency	99%	
Number of string	2	2
<b>AC output</b>		
Max. applicable motor output power	3kW	3.7kW
Rated output voltage	220-230Vac 3-phase	220-230Vac 3-phase
Output frequency range	0-50/60Hz	0-50/60Hz
Rated output current	14A	17A
<b>Mechanical data</b>		
Dimensions(W/H/D)	330/450/152(mm)	330/450/152(mm)
Weight	12.5kg	12.5kg
<b>System parameter</b>		
Max. efficiency	98%	98%
Protective class	I	
Protection degree	IP65	
Operating temperature range	-25 to +60 ,above 60 need derate operating	

Cooling method	Force cooling
Display	LCD
Communication interface	RS485/WiFi
Altitude	3000m; above 3000m need derate operating
Noise emission	< 50dB
Compliance	EN 50178; IEC/EN 62109-1; IEC 61800

## **11 Appendix B**

### **11.1 Quality Assurance**

The product malfunction in the warranty period, Hefei JNTECH will be free repair or replacement products. The warranty period take the contract as a standard.

#### **Evidence**

During the warranty period, customers should provide the invoices for the purchase of products and date. And the trademarks of the products should be clearly visible. Otherwise we do have the right not to assume quality assurance.

#### **Conditions**

The replaced products should be returned to Hefei JNTECH.

Hefei JNTECH should be given reasonable time to repair the malfunctioning equipment.

#### **Exemption from liability**

The company has the right not to carry out quality assurance in the following:

Transport damage

Incorrect installation, modification and usage.

Overall, components have been beyond the warranty period.

Bad operating environment beyond the descriptions in this manual.

Non company services, personnel to repair, replacement or demolition cause machine damage.

Damage caused by abnormal natural environment.

If the product size and parameters have changed, the latest information given by the company shall prevail without notice.

## **11.2 Contact Us**

If you have any question about Solar pumping inverter, please contact us, and we will be happy to give you answers. Please remember the following contact information.

Add: No.8 Huayuan Road Baohe industrial parts Hefei, 230051 P.R. China.

Tel: +86-551-62931312 ( 0323 )

Fax: +86-551-65393686

Website: <http://www.jntechenergy.com>

E-mail: [sales@jnnewenergy.com](mailto:sales@jnnewenergy.com)



## Hefei Jntech New Energy Co., Ltd.

 No.8 Huayuan Road Baohe Industrial Park Hefei China 230051

 +86-551-62930323

 +86-551-65393886

 [service@jnnewenergy.com](mailto:service@jnnewenergy.com)

 [www.jntechenergy.com](http://www.jntechenergy.com)